



# ABE | TRADE SOLUTIONS

**RIELES Y SISTEMAS CARTON FLOW**

---

NUESTROS CARRILES OFRECEN SOLUCIONES SENCILLAS QUE DAN VIDA A TU ALMACEN

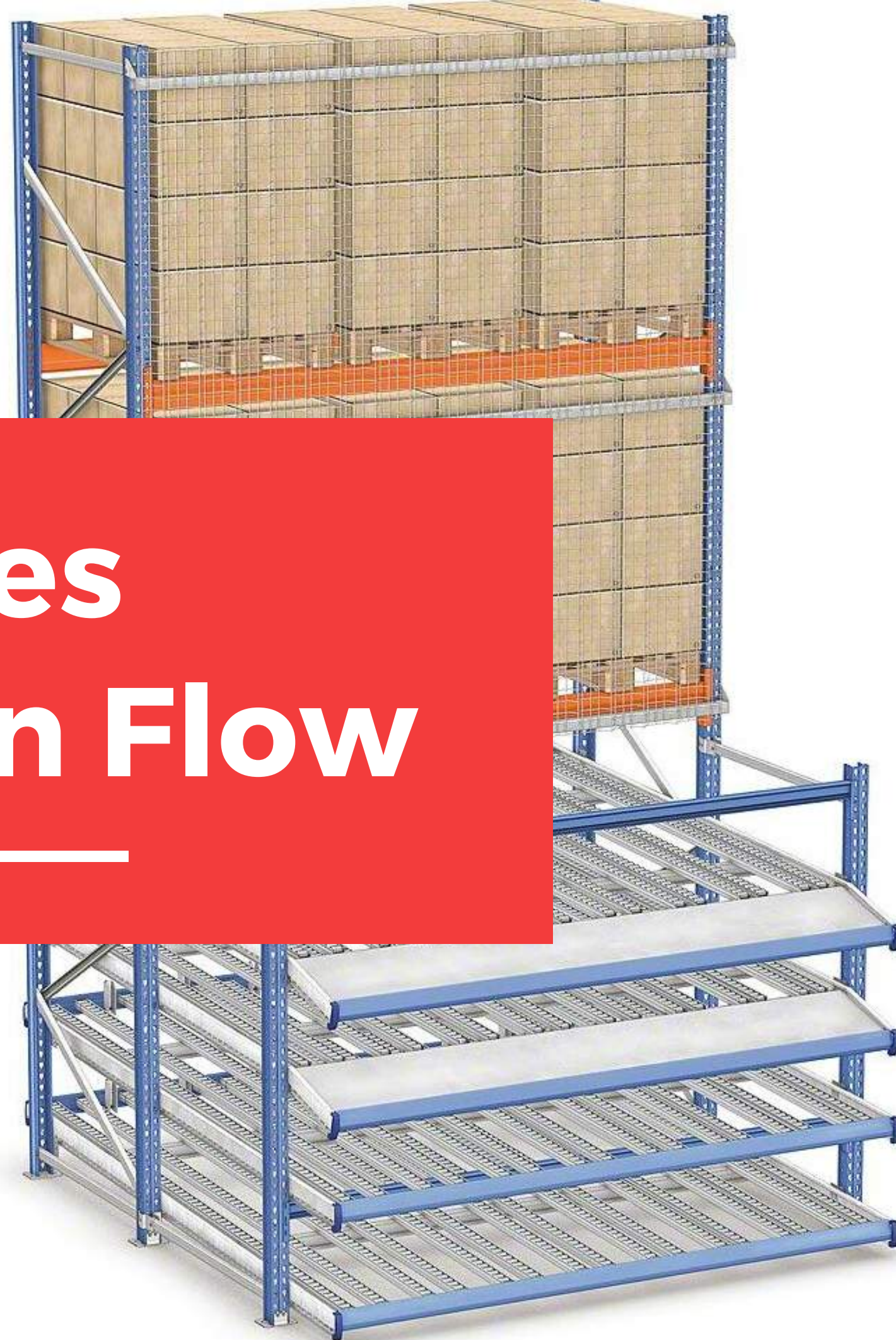

# Carriles Carton Flow

---

## Sistema Carton Flow

Nuestros carriles y rieles carton flow son desarrollados con la finalidad de mejorar el flujo de la cadena de suministros a través de la organización y almacenamiento de productos y materiales de manera segura y dinámica.

## Sistema Carton Flow

- Mejorar la rotación del producto. Sistema FIFO
- Mejorar la organización de la mercancía e inventario
- Referencias al frente de las estanterías
- Reducir el tiempo de preparación de pedidos
- Aumentar la capacidad de producción



# Ventajas de este Sistema

---



# Sistema Carton Flow

---

Nuestro sistema Carton Flow esta pensado áreas del almacén con un mayor volumen de packing, ya que aumentan el número de líneas a preparar y evitan desplazamientos del personal que realiza dichas operaciones.

Además de ser un sistema de integración e instalación sencilla y versatil.



Nuestros carriles son **líderes** en el mercado **Europeo** por su relación calidad / costo lo cual nos está permitiendo posicionarnos como una alternativa para los fabricantes de **Racks en México.**

Nuestros carriles y rieles carton flow **son fabricados en Europa** bajo los más estrictos estándares de calidad.

---

# Mejores Tiempos de Entrega

---



Nos esforzamos en agilizar tus proyectos, por lo que contamos con **FLETE SIN COSTO** a las instalaciones donde ejecutaras tu proyecto. Además de ofrecerte los **mejores tiempos de entrega** en el País.



# Valor Agregado

---

## KIT DE REFACCIONES

Nuestro kit de repuestos viene equipado con una reserva de barras adicionales, según el volumen del proyecto.

## POLIZA DE GARANTÍA

Nuestros Productos y Servicios cuentan con una Garantía acorde a cada proyecto, pregunta por este beneficio.

## MANTENIMIENTO PREVENTIVO

Programamos visitas para vigilar que el sistema se está usando adecuadamente.



# Carril Estándar

---

## Aplicaciones

- Deslizamientos por gravedad de todo tipo de cajas
- Comunicación entre puntos de trabajo
- Aprovisionamiento en mesas de montaje
- Deslizamientos de materiales en maquinaria



# Carril Estándar

---

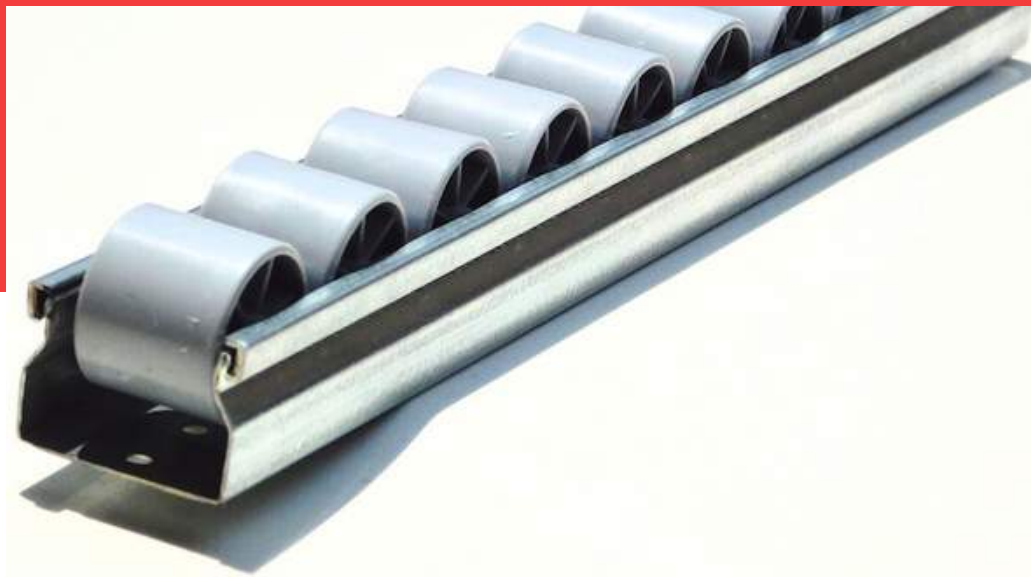

- Chapa galvanizada de 0,8mm
- Colores: Amarillo, Gris, Negro, Rojo, Blanco



- Longitud máxima de barra de 4.000 mm
- Cada rueda puede soportar 40 Kg



- Pendiente de deslizamiento de un 3.5%, dependiendo del tipo de caja

# Carril Estándar



P (mm.)	REF.
------------	------

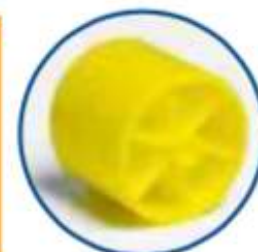

P=33	00004	00005	00006	00007	00008
P=50	00013	00014	00015	00016	00017
P=66	00023	00024	00025	00026	00027

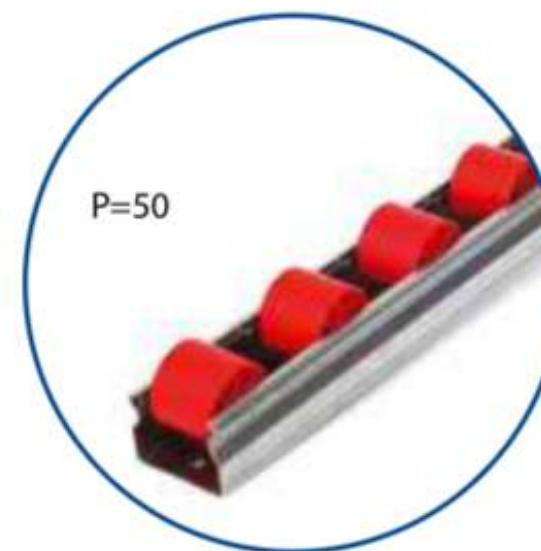

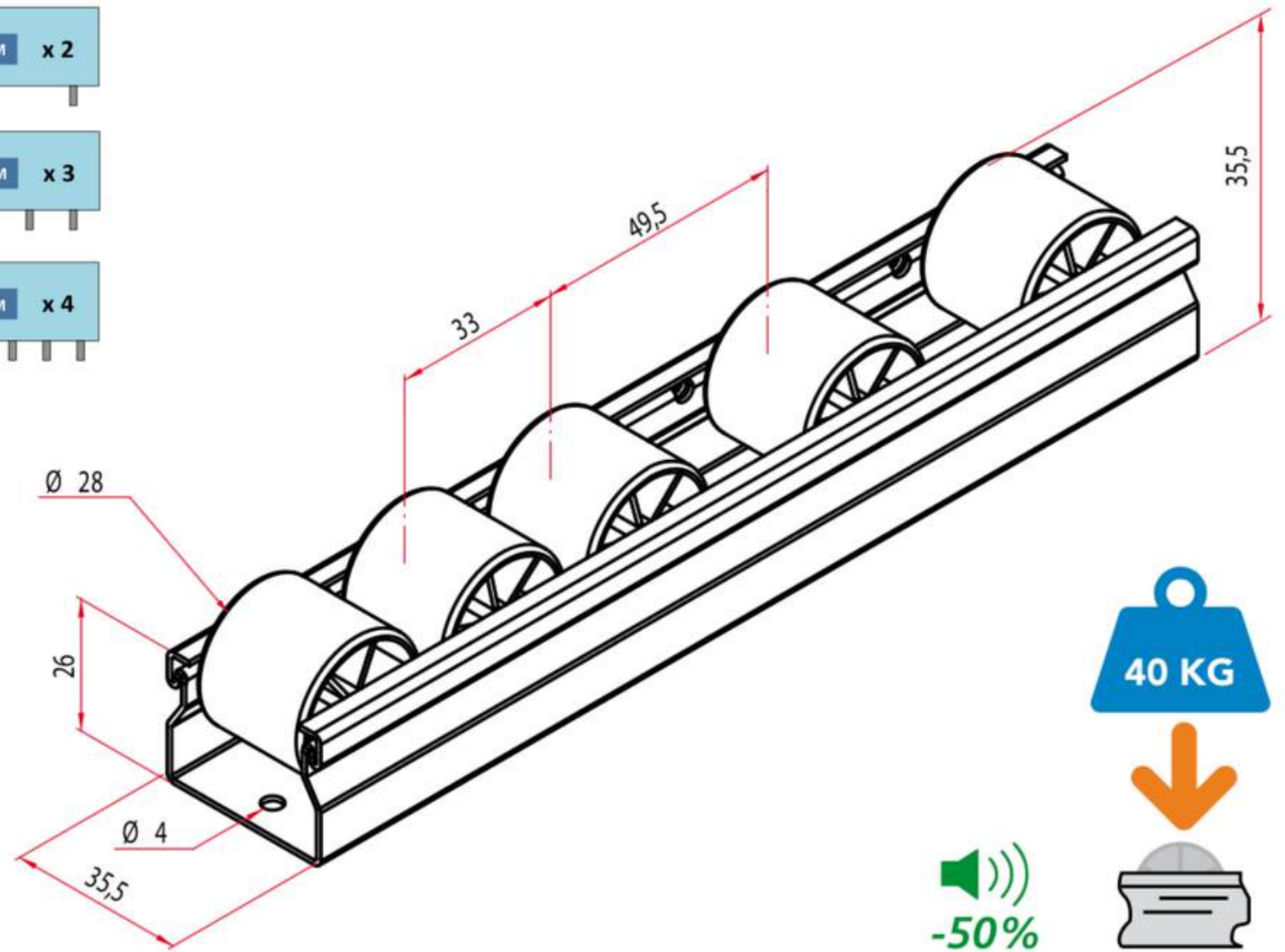
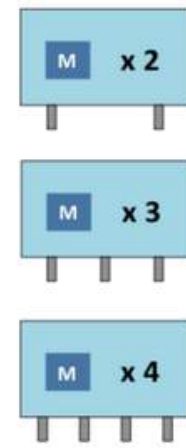
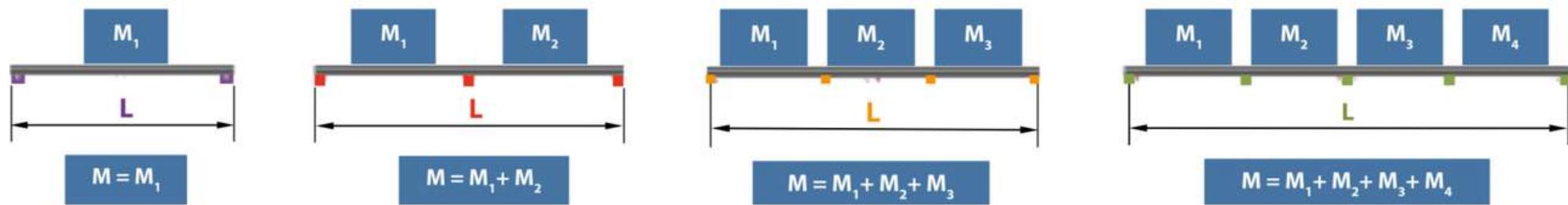
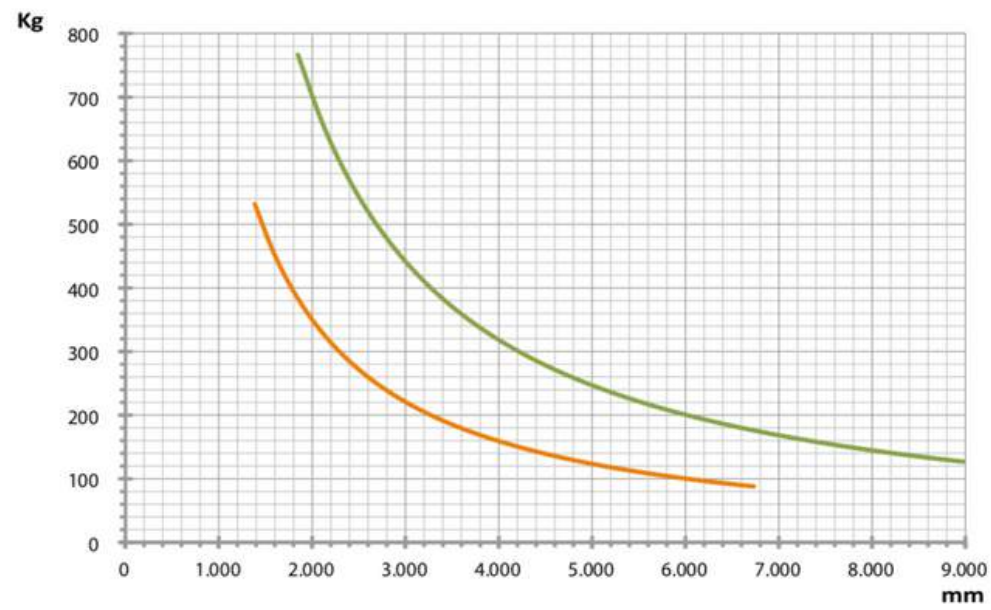
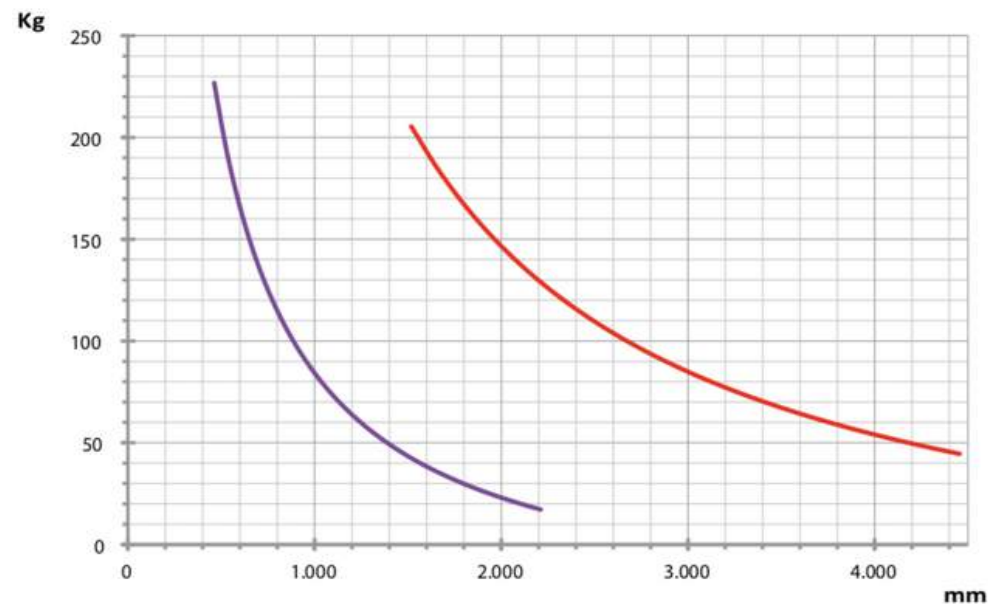

# Carril Estándar



# Carril Rueda Aleta



P (mm.)	REF.			
P=50		00033	00034	00035
P=66		00043	00044	00045
P=83		00051	00053	-



# Carril Rueda Aleta

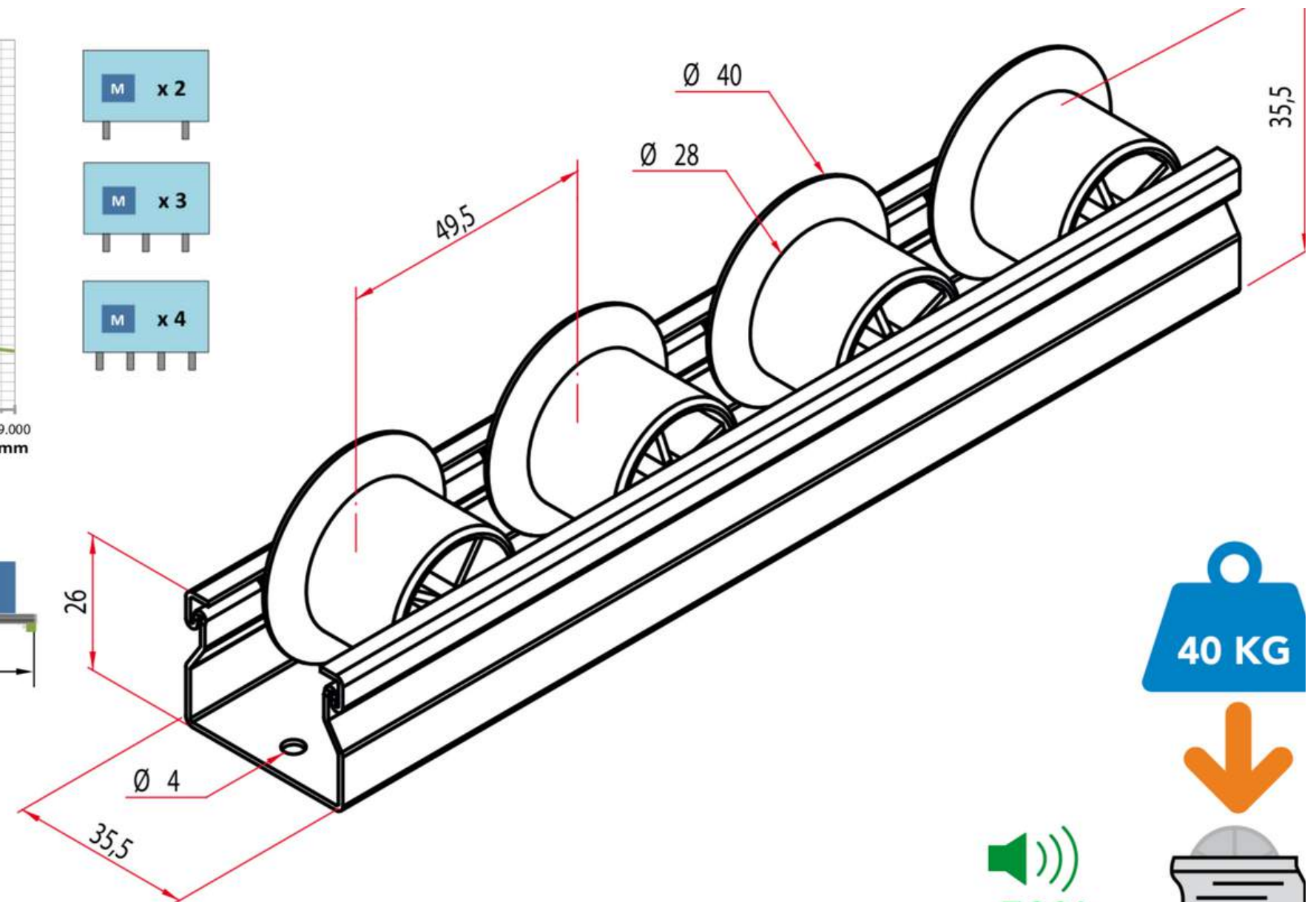
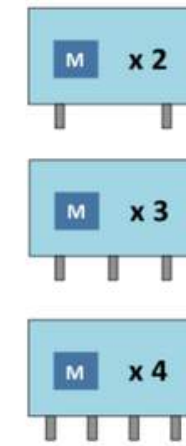
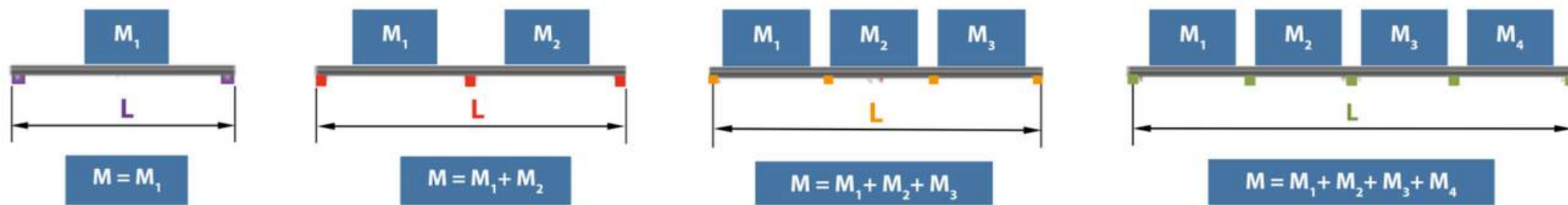
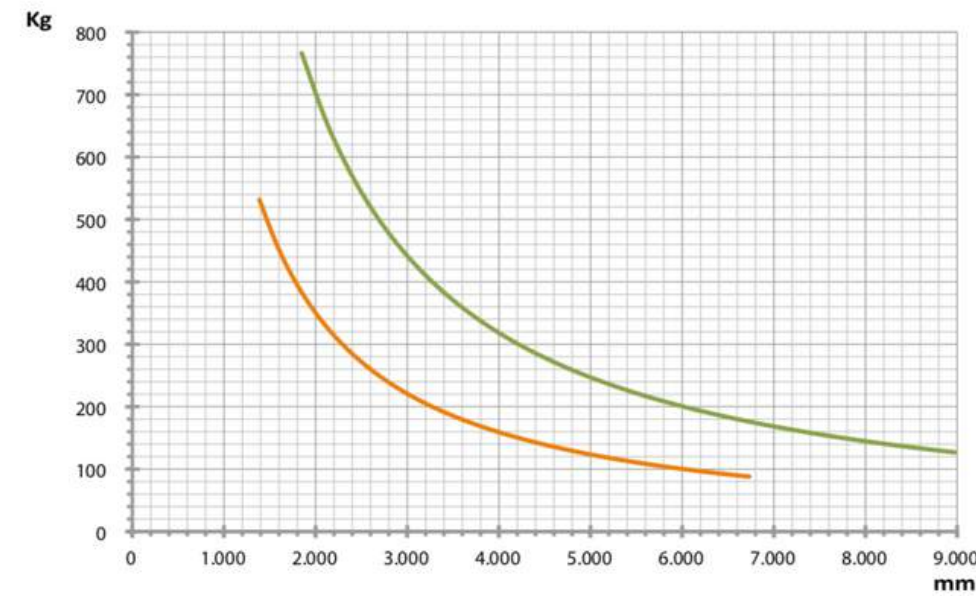
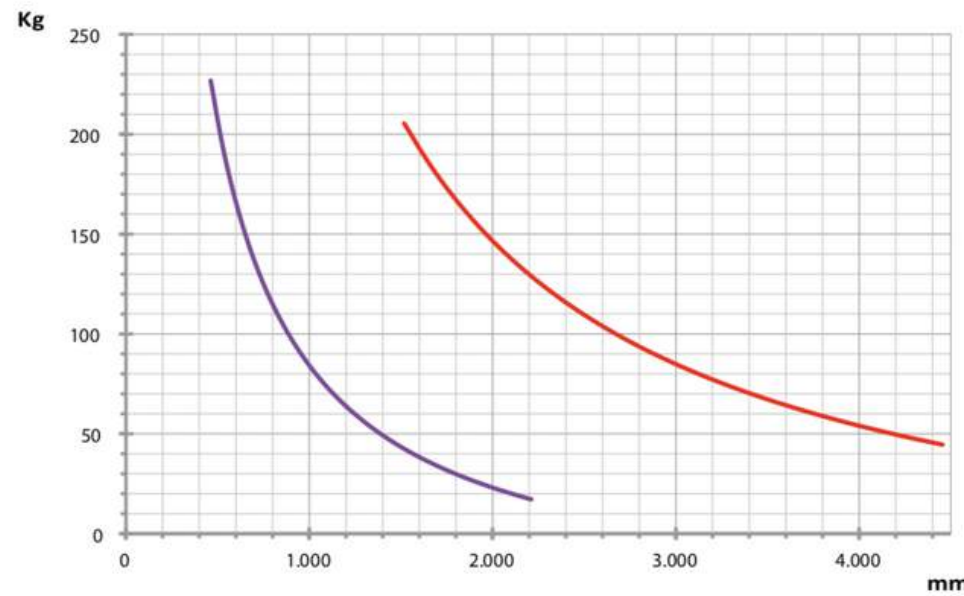

-50%

# Carril Rueda Partida

---



P (mm.)	REF.	
P=16,5	00003	



# Carril Rueda Partida

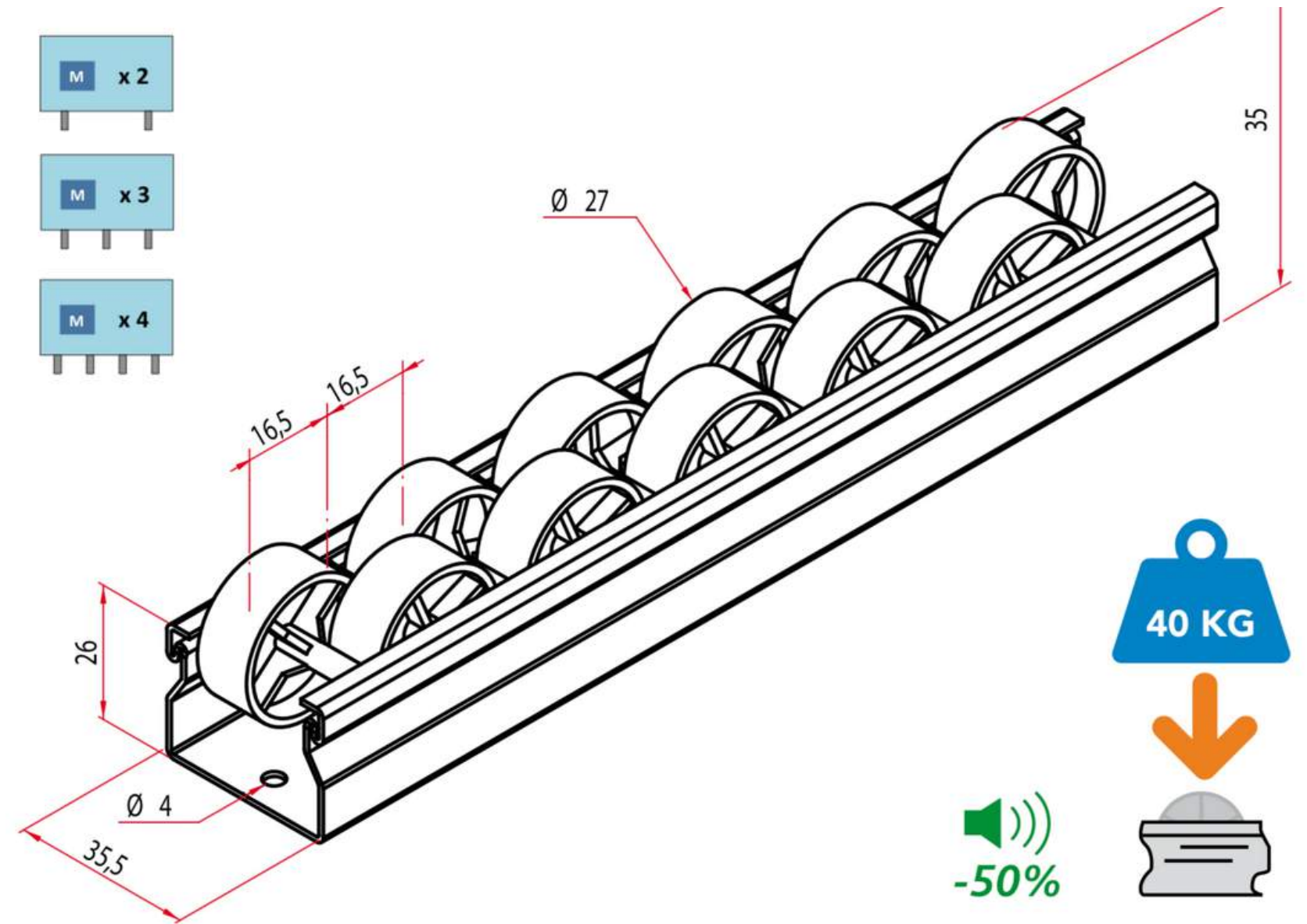
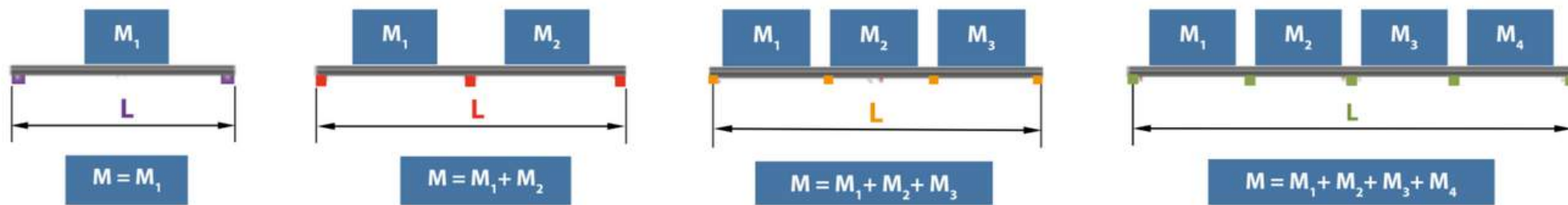
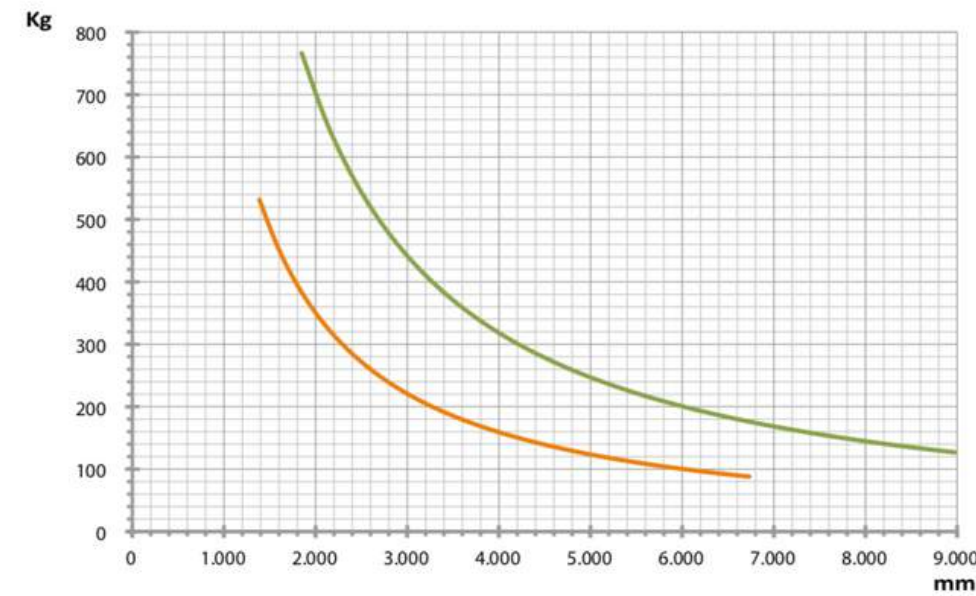
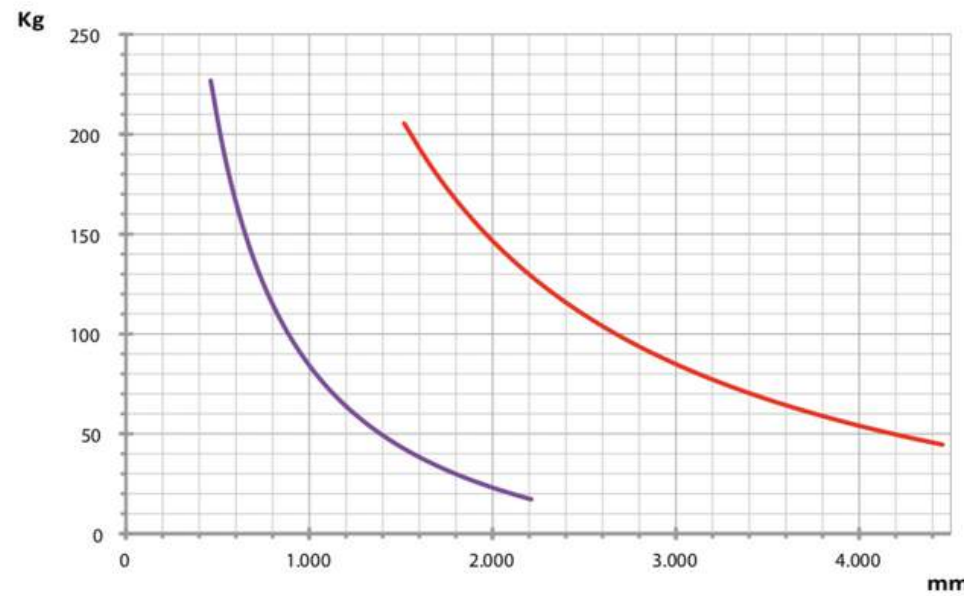

# Carril Conductivo ESD

## Aplica para Carril:

- Estándar
- Rueda Aleta
- Rueda Partida



ATEX 94/9/EC



28,8  $\Omega$ /cm<sup>2</sup>

P (mm.)	REF.
------------	------



P=33	00010
P=50	00019
P=66	00029



P=33



P=50



P=66





AMT SOLUTIONS



A close-up photograph of a brown cardboard box resting on a conveyor belt. The conveyor belt consists of a series of white rollers supported by a metal frame. The rollers are arranged in a grid pattern, and the box is positioned in the center of the frame. The background is a blurred view of the conveyor belt extending into the distance. A large, semi-transparent watermark is overlaid on the image, reading "ABE TRADE SOLUTIONS" in a bold, sans-serif font. The watermark is centered horizontally and vertically, with "ABE" on the left, "TRADE" on the right, and "SOLUTIONS" below "TRADE".

ABE | TRADE  
SOLUTIONS









ADBLE | TRADE SOLUTIONS







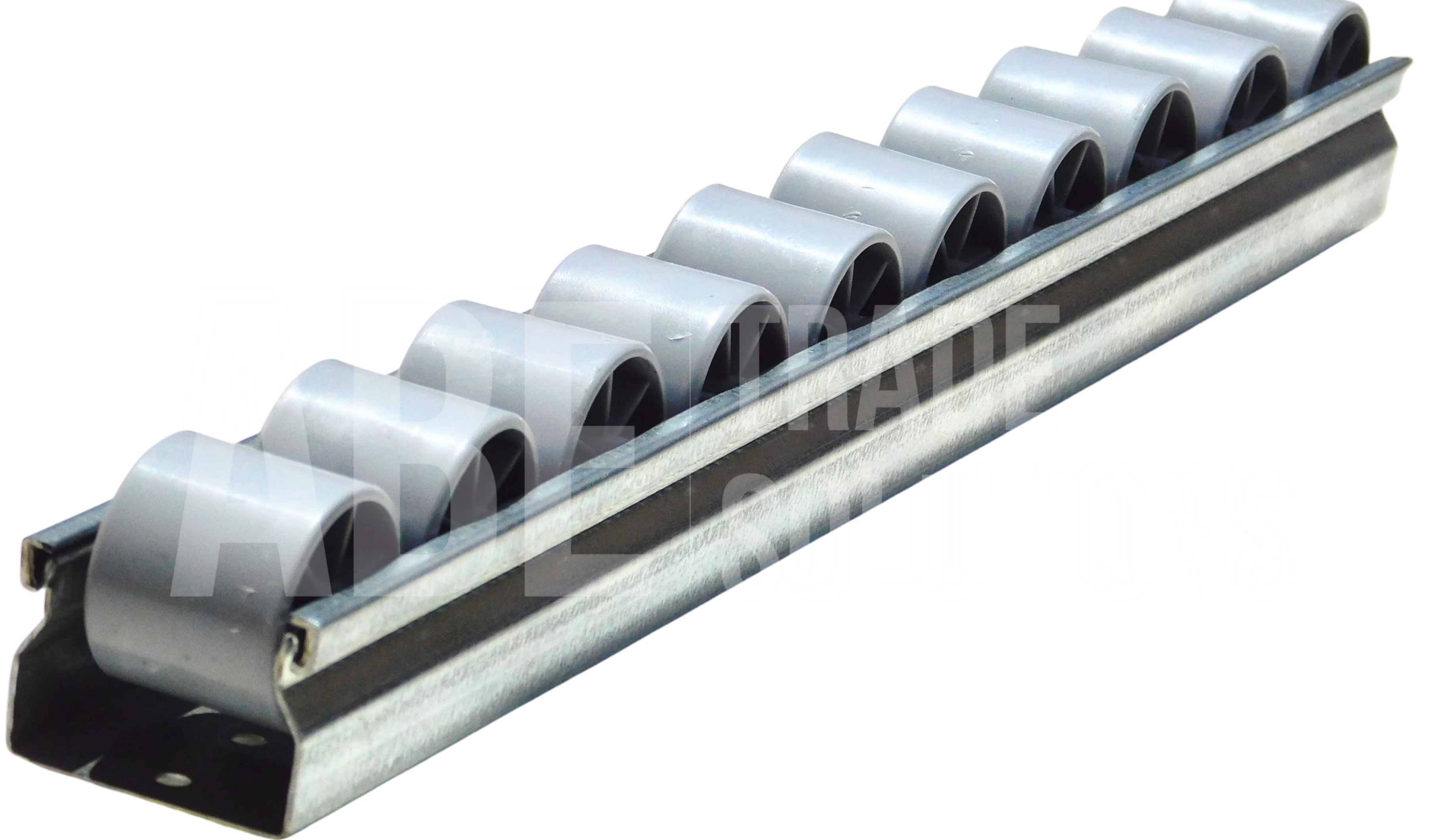



## OFICINA COMERCIAL

Cuautitlan 684-A Chapalita  
Oriente, 45040 Zapopan, Jal.

Tel: 01 33 3880 3228

Cel: +52 444 130 0579

[abeltran@abetradesolutions.com](mailto:abeltran@abetradesolutions.com)

[www.abetradesolutions.com](http://www.abetradesolutions.com)

**¡Estamos a tu disposición para  
brindarte el apoyo necesario!**



**Atención  
Personalizada**